

A800SM

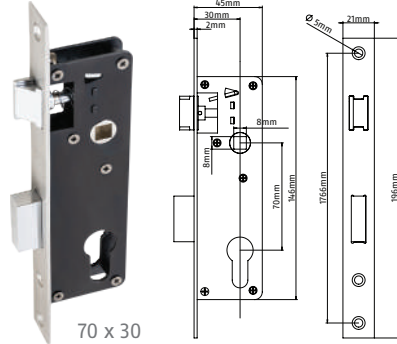

Front & Back View

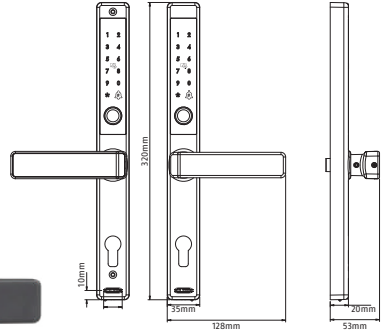

70 x 30



A93 35/35 Euro Profile Cylinder



IC Card

Works with



A8000 Smart Slim Lock

- Door Thickness: 25 - 50mm
- Unlocking Method: Fingerprint, Key, APP, Password, IC Card
- Material: Aluminium Alloy, Tempered Glass
- Fingerprint Capacity: 100
- Password Capacity: 120
- IC Card Capacity: 100
- IC Card: 2
- Key: 3
- Cylinder: Double Cylinder
- Battery Type: 4 x AAA Alkaline Batteries
- Operation Temperature: -20°C - 70°C
- FRR: <1.0%
- FAR: <0.001%

	Fingerprint Unlock		USB Type-C Charging Port
	Password Unlock, OTP (One-Time Password)		Doors hinges on left side
	Mechanical Key Unlock		Doors hinges on right side
	IC Card Access		Dual-Side Key Operation
	Mobile Apps Unlock		Anti-Drill Protection
	Low-Power Prompt		KA - Keyed Alike MK - Master Key System

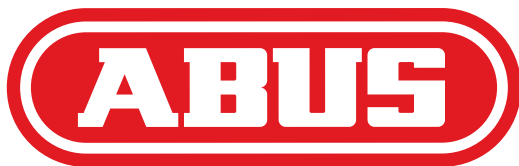

Security Tech Germany



Smart Door Lock User Manual

A8000SM

Important Information

- Before using Smart Door Lock, please read and understand all instructions.
- Damage caused by non-compliance operation against the instructions will not be covered by warranty.
- Use the manufacturer specified accessories/components only.
- Use only the alkaline batteries the product is equipped with, or use the same type of batteries with the same specification.(Please DO NOT use Energizer alkaline batteries)
- Do not scrape the fingerprint sensor with sharp objects, otherwise it may cause permanent damage.
- Do not expose the product to corrosive substances, in case the outer casing protective layer being damaged.
- Do not hang any objects on the handle, in case it might affect the normal use of the lock.
- Please clean the product with a soft cloth.
- Do not remove the batteries during set-up operation.
- Please let a professional technician to install the lock as per the installation guidelines provided.
- Do not disassemble the lock by yourself, Keep the relevant seal labels properly.
- Please modify the default master code immediately after installed and debugged
- Please keep the mechanical key properly and do not leak your password info easily.
- Please replace all the batteries immediately if there is a low battery alarm. Please make sure to correctly match the poles (+/-)when installing the batteries.

CAUTION

- Do not place the battery close to the fire source to avoid explosion.
- Do not use any emergency power supply that does not meet the safety requirements to power the product.
- Do not connect the 2 poles of the batteries with metals to avoid short circuit which may lead to an explosion.
- Please make sure any component replacement is executed by Abus, Abus authorized service center or professional technicians.
- Do not use accessories or components that have been produced by other manufacturers or have not been specifically recommended by Abus. Use of such accessories and components may void your warranty.

ATTENTION PLEASE



- *The default master code is 123456.

List of Parts

3085 Mortise × 1

Door Strike Plate × 1

Double-sided Cylinder Lock × 1

Spindle × 1

Black Cylindrical Rubber Plugs × 2

M5 Female Screw Spacer × 2

2.5mm Allen Key × 1

Opening Sleeve × 1

Drilling Template × 1

M5×30 Phillips Flat Head Screw × 1

M5×15 Phillips Pan Head Screws × 2

M4×20 Phillips Self Tapping Screws × 4

M4×10 Phillips Flat Head Screws × 2

Product Overview

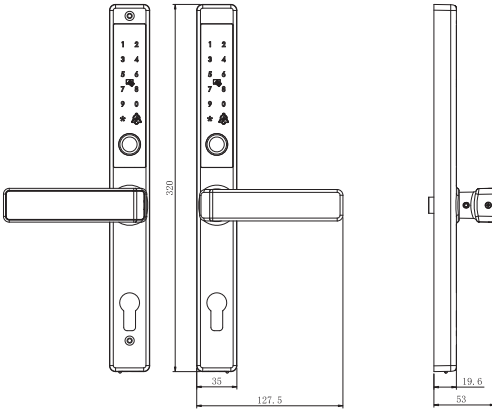

Precautions Before Installing the Lock

1.Changing the Handle Direction

Use an Allen key to loosen the set screws on both sides.

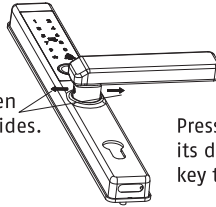

Press out the handle to change its direction, then use an Allen key to tighten the screws.

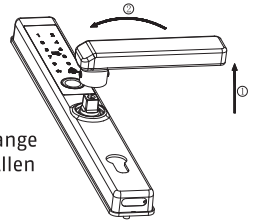

2.Spindle Adjustment

Align the black dot on the spindle with the handle.

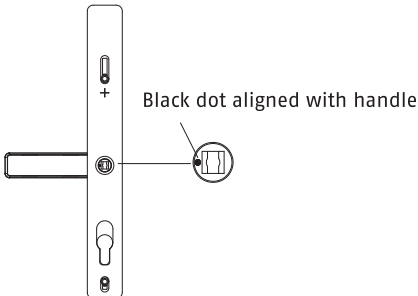

Installation Steps

1. Use the drilling template to drill holes at the respective positions on the door panel. Insert the mortise into the door panel's mortise slot and secure it with two screws. Then, install the cylinder.

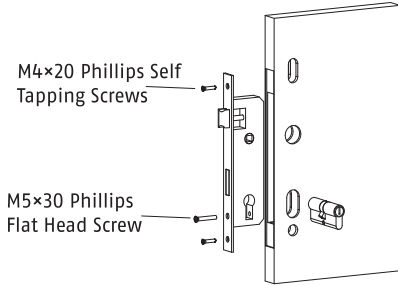

2. Insert the 2 studs into the front lock case base plate. Insert the spindle into the shaft core and secure it with the split pin. Rotate the spindle to align the black dot with the handle.

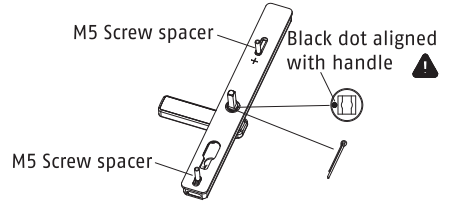

3. Pass the front lock casing connection wire through the interior base plate. Then, press the interior base plate and the rubber pad tightly against the inner side of the door. Secure the front lock casing with 2 M5 screws.

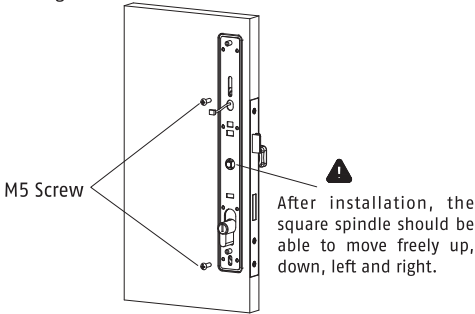

4. As with the front lock, rotate the interior lock spindle so that its black dot aligns with the handle.

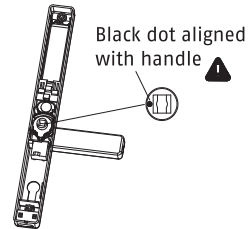

5. Connect the front lock's wire to the interior lock. Then, insert the wire into the door and secure it using black M4 flat head screws.

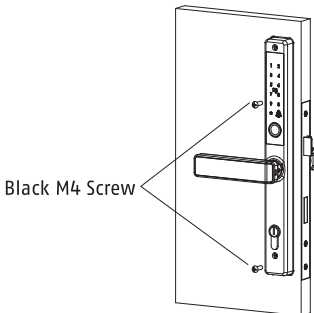

6. Unscrew the screw at the end of the interior handle and remove the battery compartment cover. Insert 4 AAA alkaline batteries. Follow the user manual to check functionality. Once confirmed, reinstall the battery compartment cover and insert the black cylindrical rubber plugs.

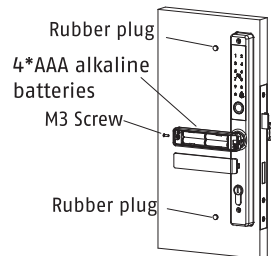

Using the USB Emergency Power Supply

There is a Type-C port at the bottom of the front panel of the smart lock, which can be connected to a power bank or a 5V power source for emergency power supply.

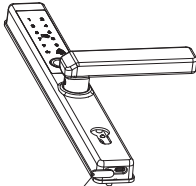

Pull open the waterproof cover — Emergency power supply port

Using the Setup Button

There is a setup button on the lower back side of the interior panel of the smart lock. To access the setup button, remove the two black M4 screws and detach the interior panel.

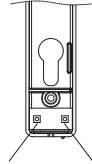

Front panel setup button — Interior panel setup button

Additional Locking Step

Lift the front or interior handle upwards to extend the square bolt of the lock body.

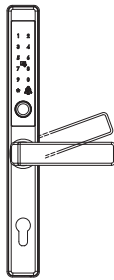

Lift front handle

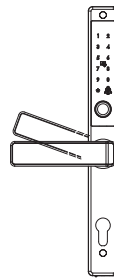

Lift interior handle

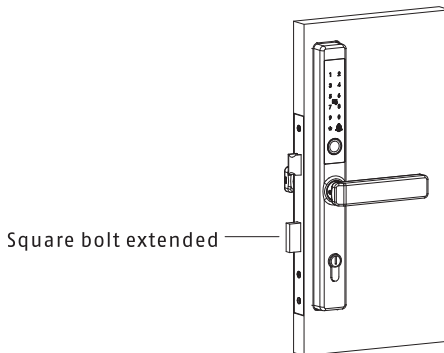

Square bolt extended

Performance Specifications

Item	Specifications	Remarks
Operating Voltage	4.8–6V	Standard alkaline battery voltage: 6V
Low Voltage Alert	4.8±0.2V	① Low battery power ② Allow up to 50 times additional unlocking operation
Standby Power Consumption	≤60 μA (single panel)	
Active Power Consumption	≤500 mA (includes peak motor current)	
USB Emergency Unlocking	5V / 1A	
Operating Temperature	-25°C to +70°C	Complies with GA374-2019 standard
Storage Temperature	-20°C to +60°C	
Humidity Requirement	< 90% RH	
ESD Protection	Contact ±8kV, Air ±15kV	

Function Specifications

Item	Specification	Alarm Type	Remarks
Error Lockout Alarm	After 5 consecutive incorrect fingerprint/password/card attempts are made within 3 minutes, the system triggers an alarm and announces "System locked", and the system locks for 90 seconds.	After a brief lock alarm, the system enters sleep mode. Upon reactivation, it briefly alarms again before returning to sleep mode.	No operations can be performed during the lockout period.
Low Voltage Alert	When the voltage drops below 4.8±0.2V, the system triggers an alert with the voice prompt "Low battery, please replace the battery."		
Access Operation Menu	After activating the screen, press (*+#) and verify as an administrator to enter the function operation menu.		
Anti-Peeping Password	To prevent peeping, random digits can be entered before or after the actual password, with a maximum length of 20 digits.		
Factory Settings	Any password, fingerprint or card can unlock the system.		
Remote Unlock Request	Press the # key to trigger a remote unlock request.		
Passage Function	(After unlocking and before the automatic relock, press 5 and #) The door lock will enter an always-open mode. Unlocking once more restores normal status.		

User Storage Capacity

Item	Specification	Fingerprint	Password	Card
Administrator	10	n (n≤10)	n (n≤10)	n (n≤10)
Normal User	290	Programmable	Programmable	Programmable
Temporary Password	Issued via app	/	Usable	/
Total	300	100	100	100

Factory Reset

1. Press and hold the setting button for 5 seconds, a voice prompt will announce "Press the # key to restore factory settings". At this point, press the # key to confirm restoring factory settings.
2. Access the menu using the (*+#) keys, then press the "4" key to select "Restore Factory Settings." Press the * key to return to the previous menu or the # key to confirm and proceed with the factory reset.

Basic Function Operations

1. Gently touch the screen to activate it; the keypad will illuminate in white.
2. After activating the screen in factory settings, you can unlock the door by entering any password, fingerprint or card. A voice prompt will announce "Unlocked".
3. After activating the screen in factory settings, press the (*+#) keys to enter the menu page. Press the * key to exit. If no operation is performed for 12 seconds, the screen will turn off.
4. When adding users, IDs are automatically assigned in sequence.

Menu Operations

1. Add User: Add Administrator / Add Normal User / Network Settings

Operation Method: Press the (*+#) keys to enter the menu. Enter administrator information and verify. Once verified, press "1" to access the Add User Settings menu:

- Press "1" to select Add Administrator: Enter the fingerprint, password or card to be added.
- Press "2" to select Add Normal User: Enter the fingerprint, password or card to be added.
- Press "3" to select Network Settings: Add or delete network connection.

2. Delete User

Operation Method: Press the (*+#) keys to enter the menu. Enter administrator information and verify. Once verified, press "2" to select Delete User Settings and access the operation menu.

- Enter the Delete User Menu. Input the user ID you wish to delete to proceed with removal.

System Settings

Operation Method: Press the (*+#) keys to enter the menu. Enter administrator information and verify. Once verified, press "3" to select the System Settings menu and access system configuration options.

1. Press "1" to select Volume Settings:
 - Press 6 to increase volume
 - Press 5 to decrease volume
2. Press "2" to select Unlock Mode:
 - Single Authentication Unlock
 - Combined Authentication Unlock
3. Press "3" to select Language Settings:English/Chinese
4. Press "4" to select Time Settings: Enter date and time in the format: Year-Month-Date-Hour-Minute
5. Press "5" to select Auto-Lock Delay Settings:
 - Press 6 to increase the delay
 - Press 5 to decrease the delay

Information Enquiry

Operation Method: Press the (*+#) keys to enter the menu. Enter administrator information and verify. Once verified, press "5" to select the Information Enquiry menu and enter the enquiry interface.

- Press "1" to select Time Enquiry. After entering the date, the system will announce the system operation log.
- Press "2" to select ID Enquiry. After entering the user ID, the system will announce this user's operation log.
- Press "3" to select Storage Capacity Enquiry. The system will announce the current user registration status and available storage capacity.

Network Operation Instructions

Search for "Tuya Smart" app in your mobile app store to download and install it. Use the app to pair the smart lock. Once connected, you can view unlocking records, unlock remotely, check device battery level, view device version information, etc.

1. [Add Device]: Follow the steps below to add the device.



2. [Smart Connection]: Follow the diagram to select "Lock (Wi-Fi)" and enter the correct Wi-Fi network password.

- Tap "EZ Mode"
- The app will automatically search for the device
- Tap to add the detected device

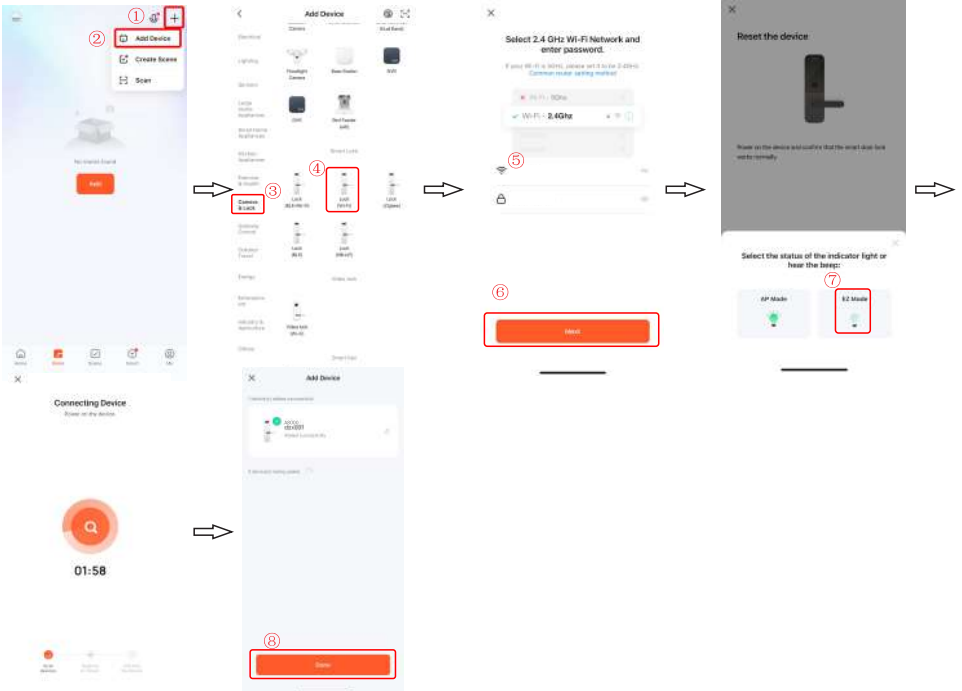

Function Overview

1. Check Device Battery Level
2. Check Device Alerts
3. Check Unlock Records
4. Member Management – Open the Add Member page in the app and follow the steps to enter information on the lock
5. Set Temporary Passwords
6. Smart Integration (e.g. notifications when family members arrive home)

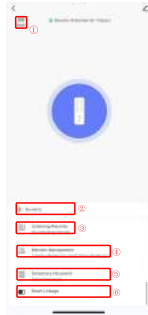

Member Management

1. Add User: Select the family member to be added.

→ Tap "Add"

→ Follow the steps to activate the door lock panel and enter "5#".

When the voice prompt announces "Please enter unlocking information", enter the user information (e.g., fingerprint, password or card). The voice prompt will announce "Operation successful" upon successful addition.

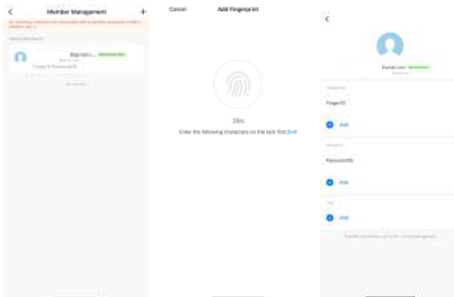

Remote Unlock and Temporary Password

1. Remote Unlock: At the lock, press the # key. The app will automatically display the remote unlock operation page. Select "Unlock" or "Reject" by swiping the corresponding option in the app. If no action is taken within 40 seconds, the lock will automatically enter sleep mode.



2. Temporary Password: In the app, tap “Temporary Password”. Set the password's validity period and generate the temporary password. Activate the lock panel and enter the generated password to unlock.

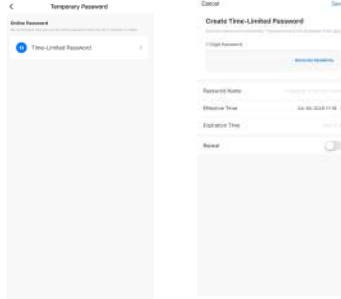

Information Enquiry

- 1. Alarm Enquiry (View reports for low battery alarm, failed attempt alarm, door not closed alarm)
- 2. Unlocking Information Enquiry (View reports for unlocking via fingerprint, password or card, remote unlock logs, temporary password unlock records)



Security Tech Germany

WARRANTY CARD

Thank for choosing Smart Door Lock

Customer Name	:	
Contact No.	:	
Date of purchase	:	
Product Model	:	
Serial No.	:	
Key Code	:	
Warranty Period	:	2 years from the purchase date

IMPORTANT

This warranty is valid only in the presence of this warranty card with the original invoice. Please keep it properly.